

;PM=:F

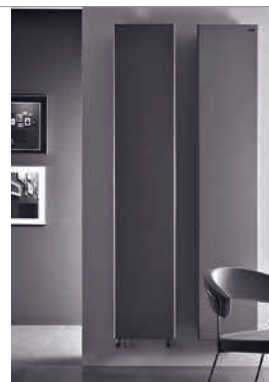

[X] attacco standard
standard connection
raccord standard
standard Anschluss
conexión estándar

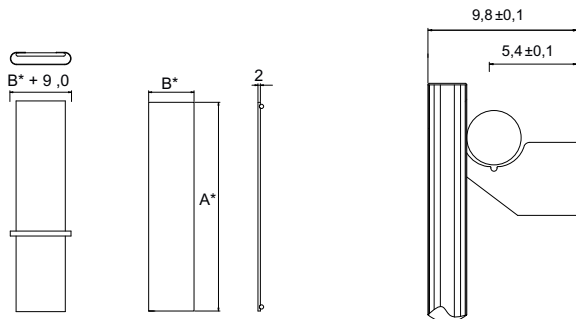
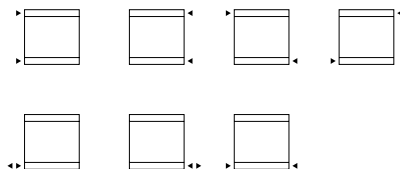

[B] attacco speciale
special connection
raccord spéciale
speziell Anschluss
conexión especial

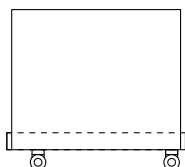

[B5] attacco interasse 5 cm
pipe centres 5 cm
raccords 5 cm
5 cm Achsabstand Anschluss
conexión entre ejes: 5 cm.

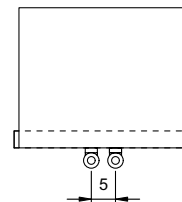

P* 122/124

verticale / vertical / verticale / vertikal / vertical

A* cm	inches	B* cm	inches	l* cm	inches	l* cm	inches	art*	L*	BTU Δt 50°	watt Δt 50°
63.0	24.8	83.0	32.7	56.0	22.0	89.0	35.0	TF25000S060022B	6.5	1 833	537
103.0	40.6	39.8	15.7	96.0	37.8	45.8	18.0	TF25000S100010B	4.6	1 320	387
103.0	40.6	54.2	21.3	96.0	37.8	60.2	23.7	TF25000S100014B	6.4	1 849	542
123.0	48.4	39.8	15.7	116.0	45.7	45.8	18.0	TF25000S120010B	5.4	1 560	457
123.0	48.4	54.2	21.3	116.0	45.7	60.2	23.7	TF25000S120014B	7.5	2 186	640
153.0	60.2	39.8	15.7	146.0	57.5	45.8	18.0	TF25000S150010B	6.5	1 865	546
153.0	60.2	54.2	21.3	146.0	57.5	60.2	23.7	TF25000S150014B	9.2	2 611	765
173.0	68.1	39.8	15.7	166.0	65.4	45.8	18.0	TF25000S170010B	7.3	2 031	595
173.0	68.1	54.2	21.3	166.0	65.4	60.2	23.7	TF25000S170014B	10.3	2 843	833
173.0	68.1	68.6	27.0	166.0	65.4	74.6	29.4	TF25000S170018B	13.2	3 655	1.071
203.0	79.9	39.8	15.7	196.0	77.2	45.8	18.0	TF25000S200010B	8.5	2 359	691
203.0	79.9	54.2	21.3	196.0	77.2	60.2	23.7	TF25000S200014B	11.9	3 303	968
203.0	79.9	68.6	27.0	196.0	77.2	74.6	29.4	TF25000S200018B	15.4	4 246	1.244

Portasalvietta 48 cm / towel bar 48 cm
porte-serviettes 48 cm / der Handtuchhalter 48 cm
porta toalla 48 cm

ACTIFP048

Portasalvietta 63 cm / towel bar 63 cm
porte-serviettes 63 cm / der Handtuchhalter 63 cm
porta toalla 63 cm

ACTIFP063

A* = altezza / height / hauteur / Höhe / alto B* = larghezza / width / longueur / Breite / ancho art* = articolo / model / modèle / Artikel / artículo P* = pagina / page / page / Seite / página
l* = interasse / pipe centres / distance entre depart et retour / Achsabstand / distancia entre las conexiones
L* = contenuto d'acqua per elemento / Water content for each element / Contenu d'eau pour chaque element / Wassergehalt für Element / contenido de agua para cada elemento

Kcal = Watt x 0.860
BTU = Watt x 3.413

Watt Δt 60° = Watt Δt 50° x 1.264
Watt Δt 40° = Watt Δt 50° x 0.750
Watt Δt 30° = Watt Δt 50° x 0.518
Watt Δt 20° = Watt Δt 50° x 0.307

p max = 10.0 bar

Colori/ colours / couleurs / Farbe / colores

[BIAN] B standard
T + 30%
S + 30%
[RAL] S + 30%
RAL non inclusi in tabella
special Ral colours
couleurs Ral spéciales
RAL Farbe nicht in der Tabelle inbegriffen
colores RAL especiales

Ulteriori dettagli
Further details
Ulérieures détails
Weitere Einzelheiten
Otros detalles



P* 120



;PM6:

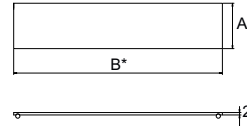
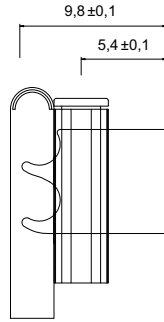

[X] attacco standard
standard connection
raccord standard
standard Anschluss
conexión estándar

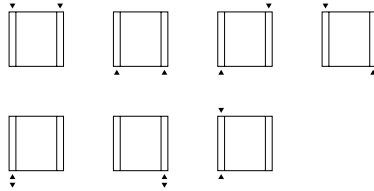

[B] attacco speciale
special connection
raccord spéciale
speziell Anschluss
conexión especial

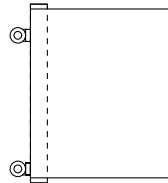

[B5] attacco interasse 5 cm
pipe centres 5 cm
raccords 5 cm
5 cm Achsabstand Anschluss
conexión entre ejes: 5 cm.

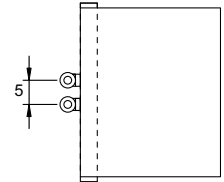

P* 122/124

orizzontale / horizontal / horizontale / horizontal / horizontal

B* cm	inches	A*cm	inches	I* cm	inches	I* cm	inches	art*	L*	BTU Δt 50°	watt Δt 50°
103.0	40.6	39.8	15.7	96.0	37.8	45.8	18.0	TO25000S100010B	4.6	1 174	344
123.0	48.4	39.8	15.7	116.0	45.7	45.8	18.0	TO25000S120010B	5.4	1 410	413
153.0	60.2	39.8	15.7	146.0	57.5	45.8	18.0	TO25000S150010B	6.5	1 765	517
173.0	68.1	39.8	15.7	166.0	65.4	45.8	18.0	TO25000S170010B	7.3	1 997	585
203.0	79.9	39.8	15.7	196.0	77.2	45.8	18.0	TO25000S200010B	8.5	2 352	689
103.0	40.6	54.2	21.3	96.0	37.8	60.2	23.7	TO25000S100014B	6.4	1 645	482
123.0	48.4	54.2	21.3	116.0	45.7	60.2	23.7	TO25000S120014B	7.5	1 973	578
153.0	60.2	54.2	21.3	146.0	57.5	60.2	23.7	TO25000S150014B	9.2	2 468	723
173.0	68.1	54.2	21.3	166.0	65.4	60.2	23.7	TO25000S170014B	10.3	2 799	820
203.0	79.9	54.2	21.3	196.0	77.2	60.2	23.7	TO25000S200014B	11.9	3 290	964
173.0	68.1	68.6	27.0	166.0	65.4	74.6	29.4	TO25000S170018B	13.2	3 597	1 054
203.0	79.9	68.6	27.0	196.0	77.2	74.6	29.4	TO25000S200018B	15.4	4 229	1 239

A* = altezza / height / hauteur / Höhe / alto B* = larghezza / width / longueur / Breite / ancho art* = articolo / model / modèle / Artikel / artículo P* = pagina / page / page / Seite / página
 I* = interasse / pipe centres / distance entre depart et retour / Achsabstand / distancia entre las conexiones
 L* = contenuto d'acqua per elemento / Water content for each element / Contenu d'eau pour chaque element / Wassergehalt für Element / contenido de agua para cada elemento



Ulteriori dettagli
Further details
Ultérieures détails
Weitere Einzelheiten
Otros detalles

Colori/ colours / couleurs / Farbe / colores

[BIAN] B standard
T + 30%
S + 30%
[RAL] S + 30%
RAL non inclusi in tabella
special Ral colours
couleurs Ral spéciales
RAL Farbe nicht in der Tabelle inbegriffen
colores RAL especiales

P* 120

Kcal = Watt x 0.860
BTU = Watt x 3.413

Watt Δt 60° = Watt Δt 50° x 1.264
Watt Δt 40° = Watt Δt 50° x 0.750
Watt Δt 30° = Watt Δt 50° x 0.518
Watt Δt 20° = Watt Δt 50° x 0.307

p max = 10.0 bar

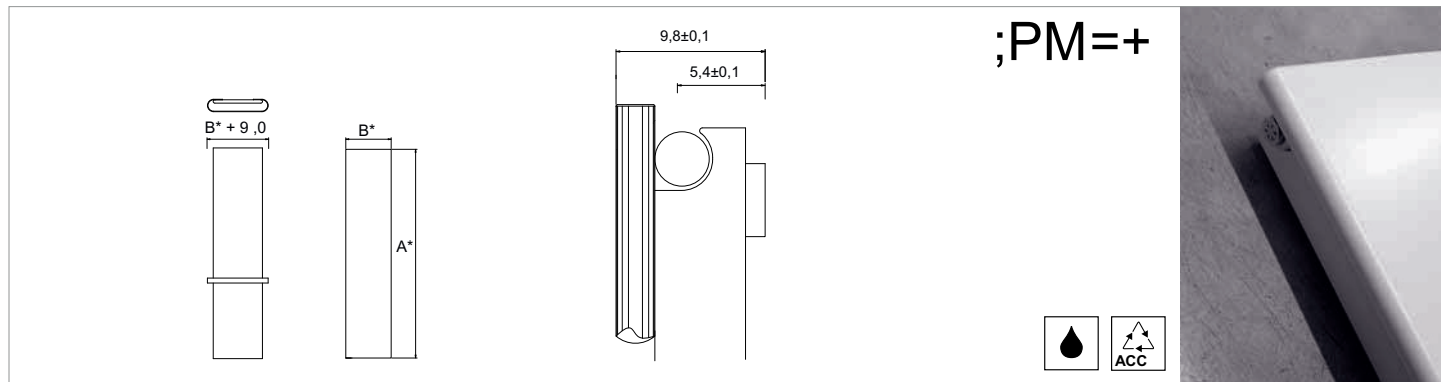

[X] attacco standard
standard connection
raccord standard
standard Anschluss
conexión estándar

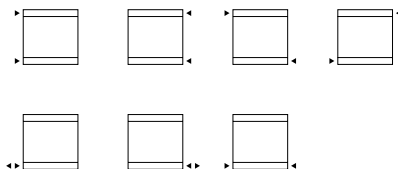

[B] attacco speciale
special connection
raccord spéciale
speziell Anschluss
conexión especial

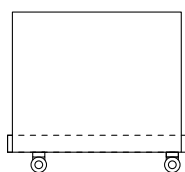

[B5] attacco interasse 5 cm
pipe centres 5 cm
raccords 5 cm
5 cm Achsabstand Anschluss
conexión entre ejes: 5 cm.

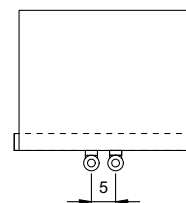

P* 122/124

verticale / vertical / verticale / vertikal / vertical

A* cm	inches	B* cm	inches	I* cm	inches	I* cm	inches	art*	L*	BTU Δt 50°	watt Δt 50°
63.0	24.8	83.0	32.7	56.0	22.0	89.0	35.0	TF25000D060022B	11.8	3 261	955
103.0	40.6	39.8	15.7	96.0	37.8	45.8	18.0	TF25000D100010B	8.5	2 285	669
103.0	40.6	54.2	21.3	96.0	37.8	60.2	23.7	TF25000D100014B	11.9	3 200	938
123.0	48.4	39.8	15.7	116.0	45.7	45.8	18.0	TF25000D120010B	10.1	2 666	781
123.0	48.4	54.2	21.3	116.0	45.7	60.2	23.7	TF25000D120014B	14.2	3 734	1 094
153.0	60.2	39.8	15.7	146.0	57.5	45.8	18.0	TF25000D150010B	12.5	3 218	943
153.0	60.2	54.2	21.3	146.0	57.5	60.2	23.7	TF25000D150014B	17.5	4 505	1 320
173.0	68.1	39.8	15.7	166.0	65.4	45.8	18.0	TF25000D170010B	14.1	3 575	1 047
173.0	68.1	54.2	21.3	166.0	65.4	60.2	23.7	TF25000D170014B	19.7	5 006	1 467
173.0	68.1	68.6	27.0	166.0	65.4	74.6	29.4	TF25000D170018B	25.4	6 436	1 886
203.0	79.9	39.8	15.7	196.0	77.2	45.8	18.0	TF25000D200010B	16.5	4 097	1 200
203.0	79.9	54.2	21.3	196.0	77.2	60.2	23.7	TF25000D200014B	23.1	5 735	1 680
203.0	79.9	68.6	27.0	196.0	77.2	74.6	29.4	TF25000D200018B	29.7	7 373	2 160

Portasalvietta 48 cm / towel bar 48 cm
porte-serviettes 48 cm / der Handtuchhalter 48 cm
porta toalla 48 cm

ACTIFDP048

Portasalvietta 63 cm / towel bar 63 cm
porte-serviettes 63 cm / der Handtuchhalter 63 cm
porta toalla 63 cm

ACTIFDP063

A* = altezza / height / hauteur / Höhe / alto B* = larghezza / width / longueur / Breite / ancho art* = articolo / model / modèle / Artikel / artículo P* = pagina / page / page / Seite / página
I* = interasse / pipe centres / distance entre depart et retour / Achsabstand / distancia entre las conexiones
L* = contenuto d'acqua per elemento / Water content for each element / Contenu d'eau pour chaque element / Wassergehalt für Element / contenido de agua para cada elemento

<p>Kcal = Watt x 0.860 BTU = Watt x 3.413</p> <p>Watt Δt 60° = Watt Δt 50° x 1.264 Watt Δt 40° = Watt Δt 50° x 0.750 Watt Δt 30° = Watt Δt 50° x 0.518 Watt Δt 20° = Watt Δt 50° x 0.307</p> <p>p max = 10.0 bar</p>	<p>Colori/ colours / couleurs / Farbe / colores</p> <p>[BIAN] B standard T + 30% S + 30%</p> <p>[RAL] S + 30%</p> <p>RAL non inclusi in tabella special Ral colours couleurs Ral spéciales RAL Farbe nicht in der Tabelle inbegriffen colores RAL especiales</p>	<p>Ulteriori dettagli Further details Ultérieures détails Weitere Einzelheiten Otros detalles</p>	
--	--	---	--

P* 120



;PM6+

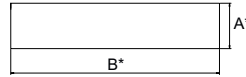
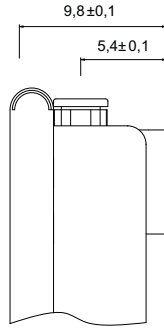

[X] attacco standard
standard connection
raccord standard
standard Anschluss
conexión estándar

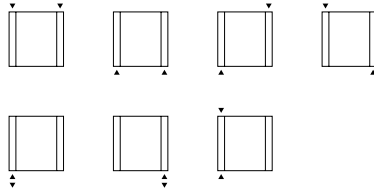

[B] attacco speciale
special connection
raccord spéciale
speziell Anschluss
conexión especial

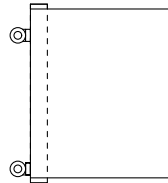

[B5] attacco interasse 5 cm
pipe centres 5 cm
raccords 5 cm
5 cm Achsabstand Anschluss
conexión entre ejes: 5 cm.

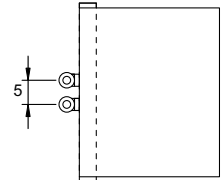

P* 122/124

orizzontale / horizontal / horizontale / horizontal / horizontal

B* cm	inches	A* cm	inches	I* cm	inches	I* cm	inches	art*	L*	BTU Δt 50°	watt Δt 50°
103.0	40.6	39.8	15.7	96.0	37.8	45.8	18.0	TO25000D100010B	8.5	2 089	612
123.0	48.4	39.8	15.7	116.0	45.7	45.8	18.0	TO25000D120010B	10.1	2 509	735
153.0	60.2	39.8	15.7	146.0	57.5	45.8	18.0	TO25000D150010B	12.5	3 137	919
173.0	68.1	39.8	15.7	166.0	65.4	45.8	18.0	TO25000D170010B	14.1	3 553	1 041
203.0	79.9	39.8	15.7	196.0	77.2	45.8	18.0	TO25000D200010B	16.5	4 181	1 225
103.0	40.6	54.2	21.3	96.0	37.8	60.2	23.7	TO25000D100014B	11.9	2 829	829
123.0	48.4	54.2	21.3	116.0	45.7	60.2	23.7	TO25000D120014B	14.2	3 396	995
153.0	60.2	54.2	21.3	146.0	57.5	60.2	23.7	TO25000D150014B	17.5	4 246	1 244
173.0	68.1	54.2	21.3	166.0	65.4	60.2	23.7	TO25000D170014B	19.7	4 809	1 409
203.0	79.9	54.2	21.3	196.0	77.2	60.2	23.7	TO25000D200014B	23.1	5 659	1 658
63.0	24.8	68.6	27.0	56.0	22.0	74.6	29.4	TO25000D060018B	9.6	2 167	635
83.0	32.7	68.6	27.0	76.0	29.9	74.6	29.4	TO25000D080018B	12.5	2 884	845
103.0	40.6	68.6	27.0	96.0	37.8	74.6	29.4	TO25000D100018B	15.4	3 604	1 056
123.0	48.4	68.6	27.0	116.0	45.7	74.6	29.4	TO25000D120018B	18.2	4 324	1 267
153.0	60.2	68.6	27.0	146.0	57.5	74.6	29.4	TO25000D150018B	22.5	5 406	1 584
173.0	68.1	68.6	27.0	166.0	65.4	74.6	29.4	TO25000D170018B	25.4	6 126	1 795
203.0	79.9	68.6	27.0	196.0	77.2	74.6	29.4	TO25000D200018B	29.7	7 208	2 112

A* = altezza / height / hauteur / Höhe / alto B* = larghezza / width / longueur / Breite / ancho art* = articolo / model / modèl / Artikel / artículo P* = pagina / page / page / Seite / página
 I* = interasse / pipe centres / distance entre depart et retour / Achsabstand / distancia entre las conexiones
 L* = contenuto d'acqua per elemento / Water content for each element / Contenu d'eau pour chaque element / Wassergehalt für Element / contenido de agua para cada elemento



Ulteriori dettagli
Further details
Ultérieures détails
Weitere Einzelheiten
Otros detalles

Colori/ colours / couleurs / Farbe / colores

[BIAN] B standard
T + 30%
S + 30%
[RAL] S + 30%
RAL non inclusi in tabella
special Ral colours
couleurs Ral spéciales
RAL Farbe nicht in der Tabelle inbegriffen
colores RAL especiales

Kcal = Watt x 0.860
BTU = Watt x 3.413

Watt Δt 60° = Watt Δt 50° x 1.264
Watt Δt 40° = Watt Δt 50° x 0.750
Watt Δt 30° = Watt Δt 50° x 0.518
Watt Δt 20° = Watt Δt 50° x 0.307

p max = 10.0 bar

P* 120