



## ArtDeco 660-F

na zem | Bodenstehend | floor standing version

**Indikace výkonu | Indikative Leistung | indicative output 75/65°C  
105 Watt  
(na článek | pro Gleid | per section)**

### Technický list | Technische Zeichnung | technical drawing

Všechny rozměry v [mm] | alle Abmessungen in [mm] | all dimensions in [mm]  
L...délka radiátoru | L...Gesamtlänge | L...length of radiator

-  Jen topení, (uzavřený) topný systém (voda)  
Nur Heizung, (geschlossenes) Heizsystem (Wasser)  
Heating only, (closed) heating system (water)
-  Kombinovaný provoz | Topení + elektrický  
Kombi-Betrieb | Wasser + Elektrisch  
Combined system | Water + electric heating
-  Jen elektrický provoz (na dotaz)  
Rein elektrisch (auf Anfrage)  
Electric version only (on request)

#### Možnosti připojení | Anschlussmöglichkeiten | Connections



úhlopříčné  
wechselseitig  
diagonal



boční  
einseitig  
one side



boční spodní L/P  
seitlich unten L/R  
bottom on side L/R

#### Rošteče pro ventily | Ventilabstände | Distances for valves

Ventil | valve ArtDECO K=55mm, V=55mm  
Ventil | valve Liberty K=55mm, V=55mm  
Ventil | valve EPOCA K=60mm, V=45mm (+10 závit | Gewinde | winding)  
Ventil | valve ANUOVA K=55mm, V=55mm  
Ventil | valve Buckingham Major K=49mm, V=49mm

Tolerance | Toleranz | tolerance +/- 5mm

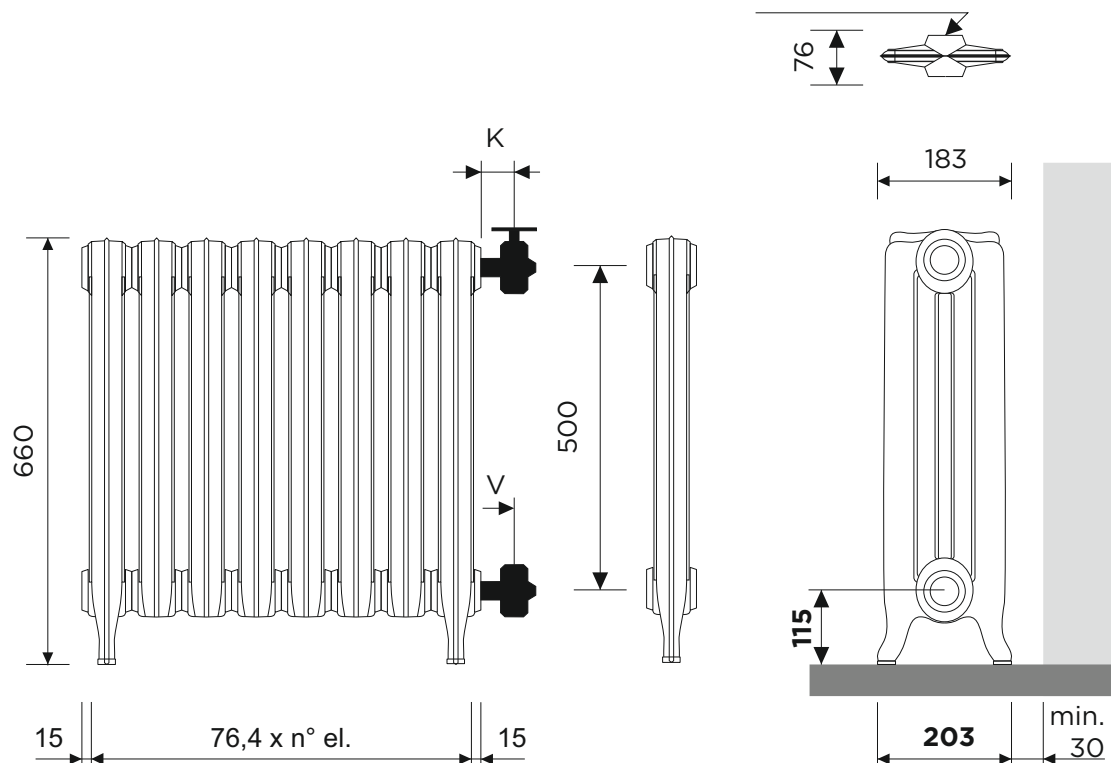

Tolerance délky | Längentoleranz | length tolerance +/- 1%



#### Litina | Gusseisen | Cast iron

šedá litina | Grauguss | grey cast iron  
3 výšky | Höhen | heights



#### Parametry | Tech.Daten | data

max. 4 bar  
max. 90° C

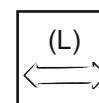

#### Délky | Längen | lengths

min. 3 max. 31 článků | Glieder | sections  
po | nach | each 76,4 mm



#### Povrch | Oberfläche | surface

RAL 7022 šedá | Umbragrau | umbra grey  
+% ostatní | andere | other RAL

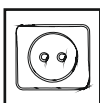

#### Elektrický | Elektrisch | el. version

~ 230V, 50Hz | max. 2000 Watt  
na dotaz | auf Anfrage | on request



#### Dodání | Lieferung | Delivery

4-6 týdnů | Wochen | weeks  
+2-4 projekty | für Projekte | for projects



## ArtDeco 660-W

na stěnu | Wandvariante | wall mounted version

**Indikace výkonu | Indikative Leistung | indicative output 75/65°C**  
**105 Watt**  
**(na článek | pro Gleid | per section)**

### Technický list | Technische Zeichnung | technical drawing

Všechny rozměry v [mm] | alle Abmessungen in [mm] | all dimensions in [mm]  
L...délka radiátoru | L...Gesamtlänge | L...length of radiator

-  Jen topení, (uzavřený) topný systém (voda)  
Nur Heizung, (geschlossenes) Heizsystem (Wasser)  
Heating only, (closed) heating system (water)
-  Kombinovaný provoz | Topení + elektrický  
Kombi-Betrieb | Wasser + Elektrisch  
Combined system | Water + electric heating
-  Jen elektrický provoz (na dotaz)  
Rein elektrisch (auf Anfrage)  
Electric version only (on request)

#### Možnosti připojení | Anschlussmöglichkeiten | Connections



úhlopříčné  
wechselseitig  
diagonal



boční  
einseitig  
one side



boční spodní L/P  
seitlich unten L/R  
bottom on side L/R

#### Rošteče pro ventily | Ventilabstände | Distances for valves

Ventil | valve ArtDECO K=55mm, V=55mm  
Ventil | valve Liberty K=55mm, V=55mm  
Ventil | valve EPOCA K=60mm, V=45mm (+10 závit | Gewinde | winding)  
Ventil | valve ANUOVA K=55mm, V=55mm  
Ventil | valve Buckingham Major K=49mm, V=49mm

Tolerance | Toleranz | tolerance +/- 5mm

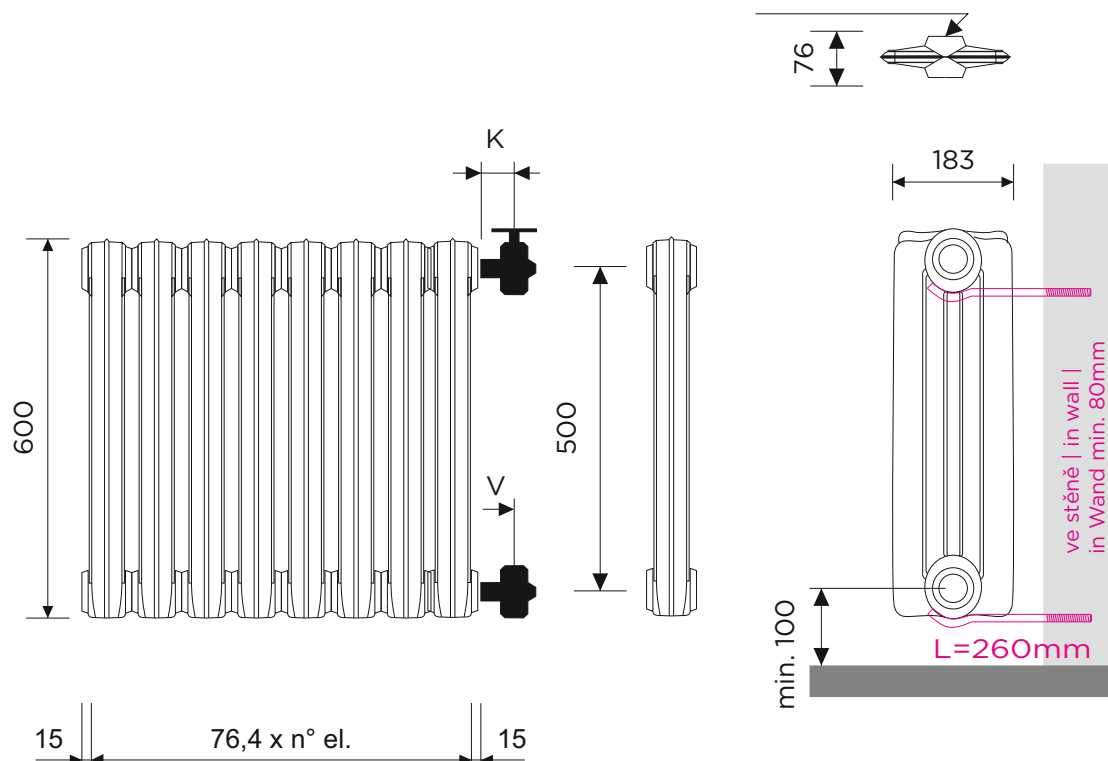

Tolerance délky | Längentoleranz | length tolerance +/- 1%



#### Litina | Gusseisen | Cast iron

šedá litina | Grauguss | grey cast iron  
3 výšky | Höhen | heights



#### Parametry | Tech.Daten | data

max. 4 bar  
max. 90° C

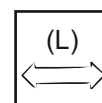

#### Délky | Längen | lengths

min. 3 max. 31 článků | Glieder | sections  
po | nach | each 76,4 mm



#### Povrch | Oberfläche | surface

RAL 7022 šedá | Umbragrau | umbra grey  
+% ostatní | andere | other RAL

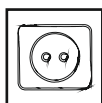

#### Elektrický | Elektrisch | el. version

~ 230V, 50Hz | max. 2000 Watt  
na dotaz | auf Anfrage | on request

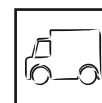

#### Dodání | Lieferung | Delivery

4-6 týdnů | Wochen | weeks  
+2-4 projekty | für Projekte | for projects



## ArtDeco 760-F

na zem | Bodenstehend | floor standing version

**Indikace výkonu | Indikative Leistung | indicative output 75/65°C  
121 Watt  
(na článek | pro Gleid | per section)**

### Technický list | Technische Zeichnung | technical drawing

Všechny rozměry v [mm] | alle Abmessungen in [mm] | all dimensions in [mm]  
L...délka radiátoru | L...Gesamtlänge | L...length of radiator

-  Jen topení, (uzavřený) topný systém (voda)  
Nur Heizung, (geschlossenes) Heizsystem (Wasser)  
Heating only, (closed) heating system (water)
-  Kombinovaný provoz | Topení + elektrický  
Kombi-Betrieb | Wasser + Elektrisch  
Combined system | Water + electric heating
-  Jen elektrický provoz (na dotaz)  
Rein elektrisch (auf Anfrage)  
Electric version only (on request)

#### Možnosti připojení | Anschlussmöglichkeiten | Connections



úhlopříčné  
wechelseitig  
diagonal



boční  
einseitig  
one side



boční spodní L/P  
seitlich unten L/R  
bottom on side L/R

#### Rošteče pro ventily | Ventilabstände | Distances for valves

Ventil | valve ArtDECO K=55mm, V=55mm  
Ventil | valve Liberty K=55mm, V=55mm  
Ventil | valve EPOCA K=60mm, V=45mm (+10 závit | Gewinde | winding)  
Ventil | valve ANUOVA K=55mm, V=55mm  
Ventil | valve Buckingham Major K=49mm, V=49mm

Tolerance | Toleranz | tolerance +/- 5mm

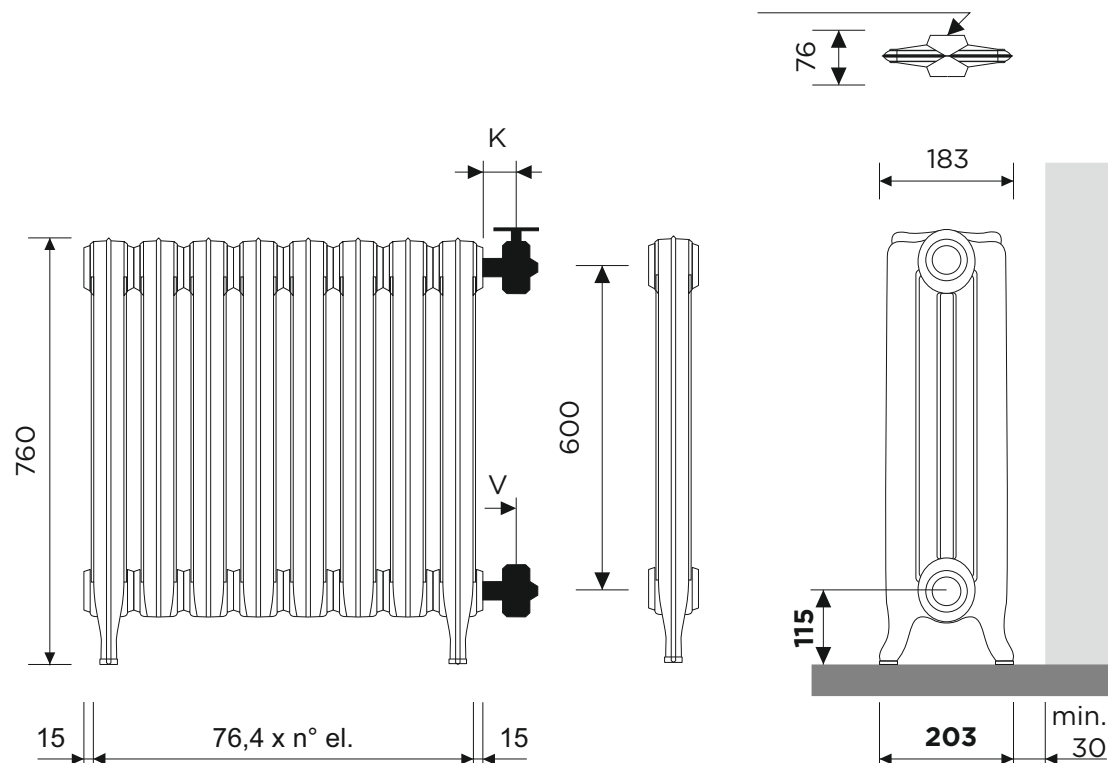

Tolerance délky | Längentoleranz | length tolerance +/- 1%



#### Litina | Gusseisen | Cast iron

šedá litina | Grauguss | grey cast iron  
3 výšky | Höhen | heights



#### Parametry | Tech.Daten | data

max. 4 bar  
max. 90° C



#### Povrch | Oberfläche | surface

RAL 7022 šedá | Umbragrau | umbra grey  
+% ostatní | andere | other RAL

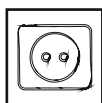

#### Elektrický | Elektrisch | el. version

~ 230V, 50Hz | max. 2000 Watt  
na dotaz | auf Anfrage | on request

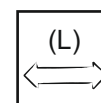

#### Délky | Längen | lengths

min. 3 max. 31 článků | Glieder | sections  
po | nach | each 76,4 mm

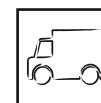

#### Dodání | Lieferung | Delivery

4-6 týdnů | Wochen | weeks  
+2-4 projekty | für Projekte | for projects



## ArtDeco 760-W

na stěnu | Wandvariante | wall mounted version

**Indikace výkonu | Indikative Leistung | indicative output 75/65°C  
121 Watt  
(na článek | pro Gleid | per section)**

### Technický list | Technische Zeichnung | technical drawing

Všechny rozměry v [mm] | alle Abmessungen in [mm] | all dimensions in [mm]  
L...délka radiátoru | L...Gesamtlänge | L...length of radiator

-  Jen topení, (uzavřený) topný systém (voda)  
Nur Heizung, (geschlossenes) Heizsystem (Wasser)  
Heating only, (closed) heating system (water)
-  Kombinovaný provoz | Topení + elektrický  
Kombi-Betrieb | Wasser + Elektrisch  
Combined system | Water + electric heating
-  Jen elektrický provoz (na dotaz)  
Rein elektrisch (auf Anfrage)  
Electric version only (on request)

#### Možnosti připojení | Anschlussmöglichkeiten | Connections



úhlopříčné  
wechelseitig  
diagonal



boční  
einseitig  
one side



boční spodní L/P  
seitlich unten L/R  
bottom on side L/R

#### Rošteče pro ventily | Ventilabstände | Distances for valves

Ventil | valve ArtDECO K=55mm, V=55mm  
Ventil | valve Liberty K=55mm, V=55mm  
Ventil | valve EPOCA K=60mm, V=45mm (+10 závit | Gewinde | winding)  
Ventil | valve ANUOVA K=55mm, V=55mm  
Ventil | valve Buckingham Major K=49mm, V=49mm

Tolerance | Toleranz | tolerance +/- 5mm

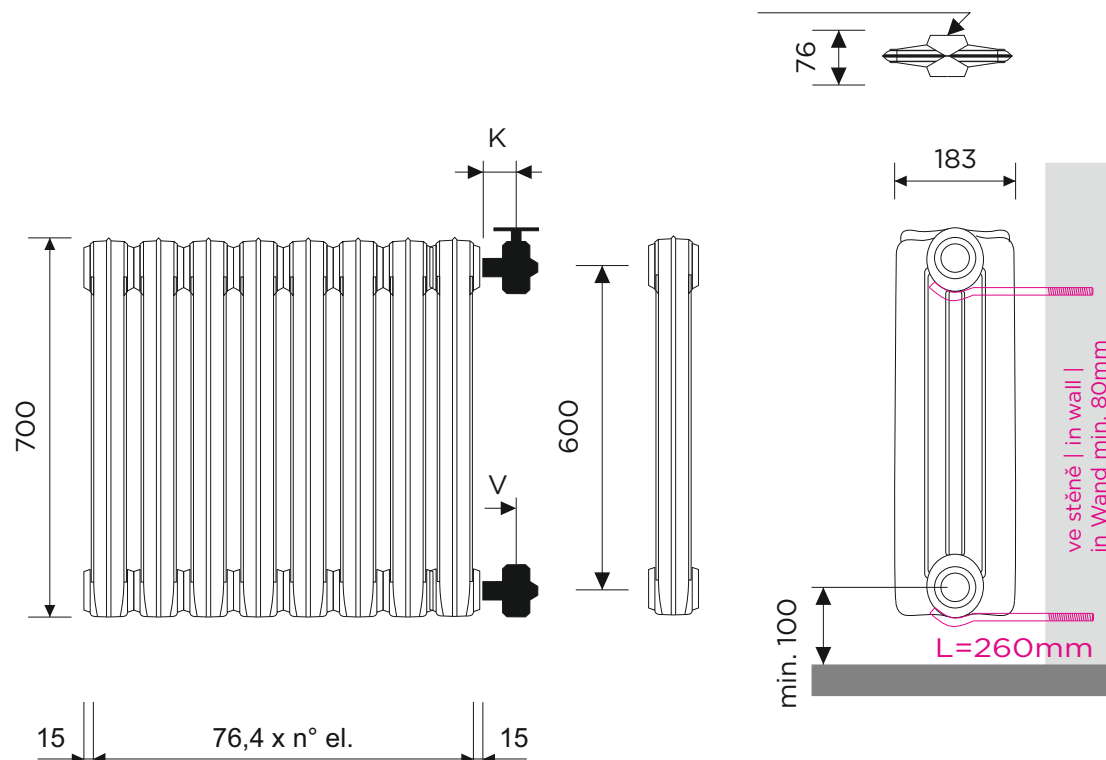

Tolerance délky | Längentoleranz | length tolerance +/- 1%



#### Litina | Gusseisen | Cast iron

šedá litina | Grauguss | grey cast iron  
3 výšky | Höhen | heights



#### Parametry | Tech.Daten | data

max. 4 bar  
max. 90° C



#### Povrch | Oberfläche | surface

RAL 7022 šedá | Umbragrau | umbra grey  
+% ostatní | andere | other RAL

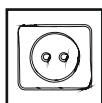

#### Elektrický | Elektrisch | el. version

~ 230V, 50Hz | max. 2000 Watt  
na dotaz | auf Anfrage | on request

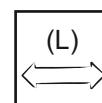

#### Délky | Längen | lengths

min. 3 max. 31 článků | Glieder | sections  
po | nach | each 76,4 mm

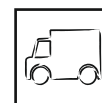

#### Dodání | Lieferung | Delivery

4-6 týdnů | Wochen | weeks  
+2-4 projekty | für Projekte | for projects



**ArtDeco 955-F**

na zem | Bodenstehend | floor standing version

**Indikace výkonu | Indikative Leistung | indicative output 75/65°C  
151 Watt  
(na článek | pro Gleid | per section)**

**Technický list | Technische Zeichnung | technical drawing**

Všechny rozměry v [mm] | alle Abmessungen in [mm] | all dimensions in [mm]  
L...délka radiátoru | L...Gesamtlänge | L...length of radiator

-  Jen topení, (uzavřený) topný systém (voda)  
Nur Heizung, (geschlossenes) Heizsystem (Wasser)  
Heating only, (closed) heating system (water)
-  Kombinovaný provoz | Topení + elektrický  
Kombi-Betrieb | Wasser + Elektrisch  
Combined system | Water + electric heating
-  Jen elektrický provoz (na dotaz)  
Rein elektrisch (auf Anfrage)  
Electric version only (on request)

**Možnosti připojení | Anschlussmöglichkeiten | Connections**



úhlopříčné  
wechelseitig  
diagonal



boční  
einseitig  
one side



boční spodní L/P  
seitlich unten L/R  
bottom on side L/R

**Rošteče pro ventily | Ventilabstände | Distances for valves**

Ventil | valve ArtDECO K=55mm, V=55mm  
Ventil | valve Liberty K=55mm, V=55mm  
Ventil | valve EPOCA K=60mm, V=45mm (+10 závit | Gewinde | winding)  
Ventil | valve ANUOVA K=55mm, V=55mm  
Ventil | valve Buckingham Major K=49mm, V=49mm

Tolerance | Toleranz | tolerance +/- 5mm

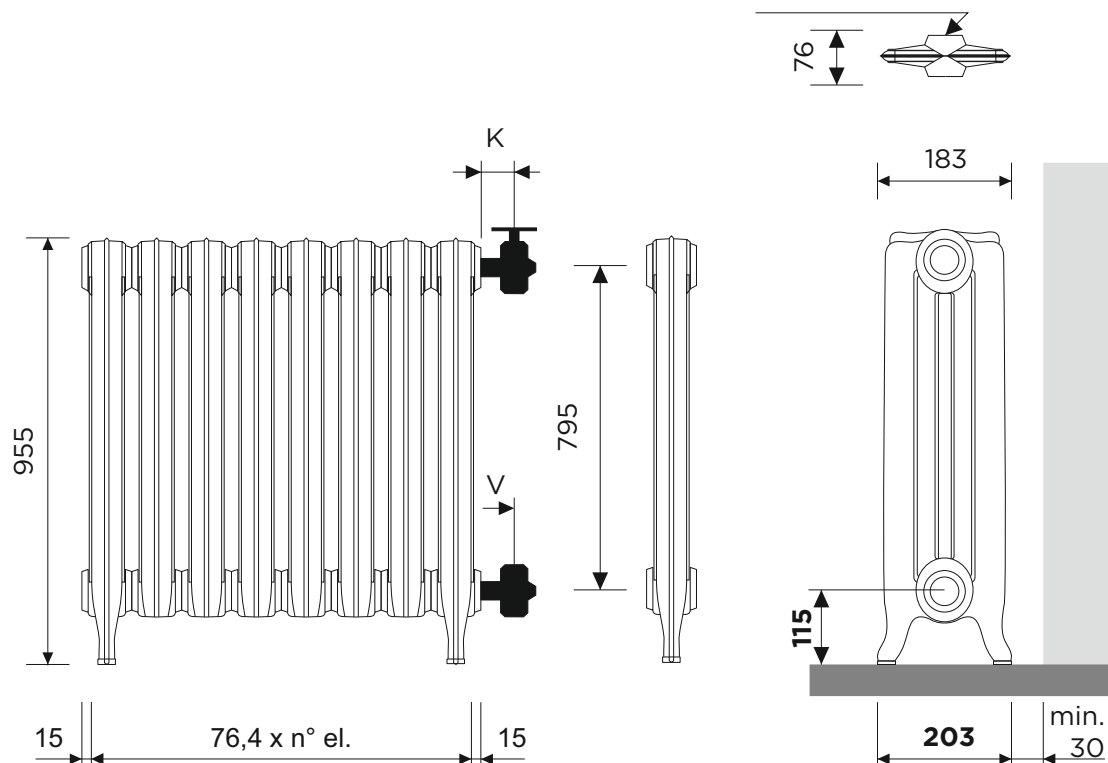

Tolerance délky | Längentoleranz | length tolerance +/- 1%



**Litina | Gusseisen | Cast iron**

šedá litina | Grauguss | grey cast iron  
3 výšky | Höhen | heights



**Parametry | Tech.Daten | data**

max. 4 bar  
max. 90° C

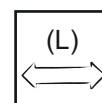

**Délky | Längen | lengths**

min. 3 max. 31 článků | Glieder | sections  
po | nach | each 76,4 mm



**Povrch | Oberfläche | surface**

RAL 7022 šedá | Umbragrau | umbra grey  
+% ostatní | andere | other RAL

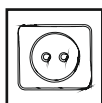

**Elektrický | Elektrisch | el. version**

~ 230V, 50Hz | max. 2000 Watt  
na dotaz | auf Anfrage | on request

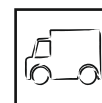

**Dodání | Lieferung | Delivery**

4-6 týdnů | Wochen | weeks  
+2-4 projekty | für Projekte | for projects



## ArtDeco 955-W

na stěnu | Wandvariante | wall mounted version

**Indikace výkonu | Indikative Leistung | indicative output 75/65°C**  
**151 Watt**  
**(na článek | pro Gleid | per section)**

### Technický list | Technische Zeichnung | technical drawing

Všechny rozměry v [mm] | alle Abmessungen in [mm] | all dimensions in [mm]  
L...délka radiátoru | L...Gesamtlänge | L...length of radiator

-  Jen topení, (uzavřený) topný systém (voda)  
Nur Heizung, (geschlossenes) Heizsystem (Wasser)  
Heating only, (closed) heating system (water)
-  Kombinovaný provoz | Topení + elektrický  
Kombi-Betrieb | Wasser + Elektrisch  
Combined system | Water + electric heating
-  Jen elektrický provoz (na dotaz)  
Rein elektrisch (auf Anfrage)  
Electric version only (on request)

### Možnosti připojení | Anschlussmöglichkeiten | Connections



úhlopříčné  
wechselseitig  
diagonal



boční  
einseitig  
one side



boční spodní L/P  
seitlich unten L/R  
bottom on side L/R

### Rošteče pro ventily | Ventilabstände | Distances for valves

Ventil | valve ArtDECO K=55mm, V=55mm  
Ventil | valve Liberty K=55mm, V=55mm  
Ventil | valve EPOCA K=60mm, V=45mm (+10 závit | Gewinde | winding)  
Ventil | valve ANUOVA K=55mm, V=55mm  
Ventil | valve Buckingham Major K=49mm, V=49mm

Tolerance | Toleranz | tolerance +/- 5mm

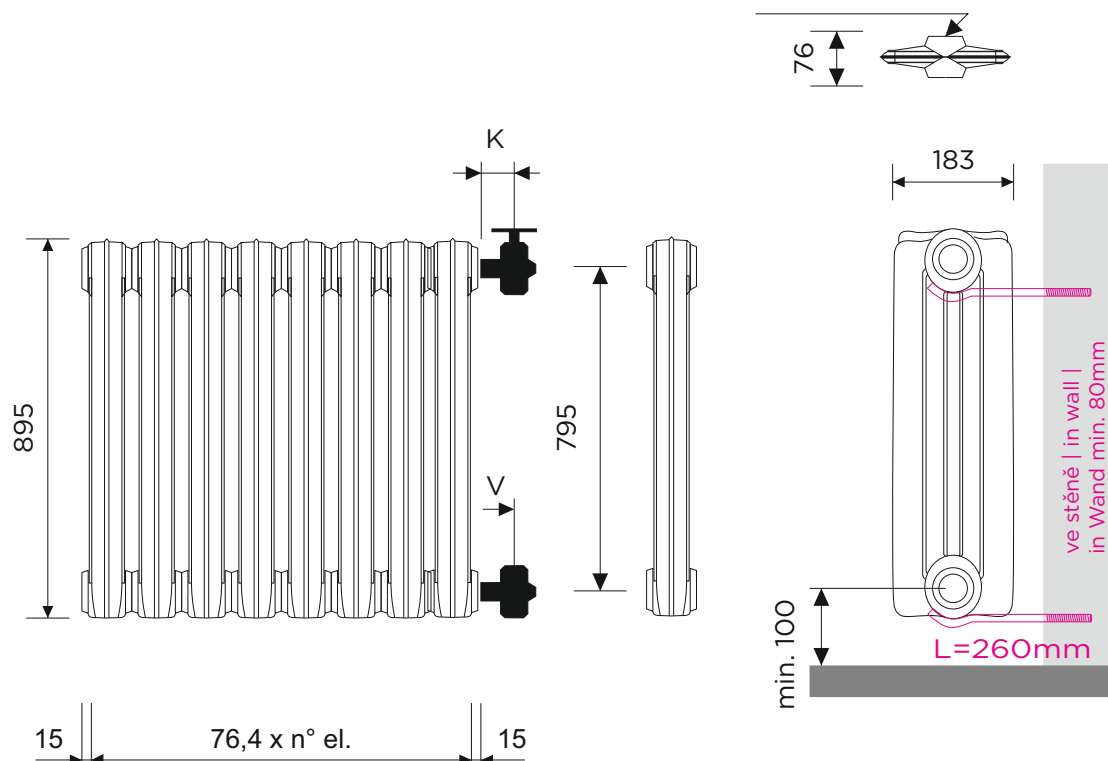

Tolerance délky | Längentoleranz | length tolerance +/- 1%



### Litina | Gusseisen | Cast iron

šedá litina | Grauguss | grey cast iron  
3 výšky | Höhen | heights



### Parametry | Tech.Daten | data

max. 4 bar  
max. 90° C

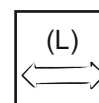

### Délky | Längen | lengths

min. 3 max. 31 článků | Glieder | sections  
po | nach | each 76,4 mm



### Povrch | Oberfläche | surface

RAL 7022 šedá | Umbragrau | umbra grey  
+% ostatní | andere | other RAL

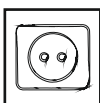

### Elektrický | Elektrisch | el. version

~ 230V, 50Hz | max. 2000 Watt  
na dotaz | auf Anfrage | on request

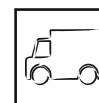

### Dodání | Lieferung | Delivery

4-6 týdnů | Wochen | weeks  
+2-4 projekty | für Projekte | for projects